



TRACK & SLIDING DOOR PRODUCT GUIDE

Applications for all building markets:



www.cnbhnp.com



CannonBall:HNP is a leading supplier of components for the post frame and metal building industries. The original producer of round track and trolley sliding door systems, CannonBall offers a wide range of building products including Entry Doors, Sliding Door Systems, Dutch Doors, Cupolas, Horse Stalls, Windows, Builders Hardware and much more.

— TABLE OF CONTENTS —

General Round Track & Sliding Door Information	2
Complete Door Systems	3-8
<i>Versatility: Kwik Frame Door Systems</i>	<i>3-6</i>
<i>Specialty: Bigg Frame Door Systems</i>	<i>7-8</i>
Round Track & Trolley Systems	7-12
<i>Versatility: Keyhole Track and Delrin Pendant Trolley</i>	<i>9</i>
<i>Utility: Bracket Types</i>	<i>10</i>
<i>Specialty: Additional Track Options</i>	<i>11</i>
<i>Specialty: Additional Trolley Options</i>	<i>12</i>
Square Track & Trolley Systems	13-16
<i>Versatility: Square Track and Adjustable Strap Trolley</i>	<i>13</i>
<i>Specialty: Additional Track Options</i>	<i>14</i>
<i>Specialty: Additional Trolley Options</i>	<i>15</i>
<i>Utility: Bracket Types</i>	<i>16</i>
Hardware & Project Prep	17-20
<i>Utility: Sliding Door Hardware Options</i>	<i>17</i>
<i>Determining Sliding Door Project Needs</i>	<i>18</i>
<i>Required Hardware Components for Sliding Door Systems</i>	<i>19-20</i>



GENERAL ROUND TRACK & SLIDING DOOR INFORMATION

THINGS TO KNOW

CannonBall recommends that each sliding door / track and trolley project begin with an understanding of the following factors that directly affect design and component choices:

Opening Size

The size of the building's opening determines both the size of the door panel and the length of track needed – and helps determine the best / most appropriate sliding door installation method (i.e. split slider, bypass or single panel).

Building Type

Metal buildings require different mounting styles than non-metal buildings, which determine the track and bracket choices.

Panel Construction

The method in which the door panels are built determines which trolley types to use (i.e. pendant bolt or strap trolleys).

Available Space on Sides

The amount of space available on the sides of the opening determines appropriate installation methodology. For instance, if project opening dimensions have five feet of open space to one side of a potential 10-foot door opening, a bypass sliding door system can be used.

Desired Mounting Location

Sliding door track attaches to a header board above the proposed opening. As such, the desired mounting locations on this header -- either on the board's wide face or smaller top edge -- are key determining factors for track variety options, bracket choices and door panel height.

Door Panel Weight

The weight of a door panel effects which track varieties or trolley types should be used on a project. Panels under 600 pounds can utilize a variety of track and trolley combinations -- but larger panels over 600 pounds should use Heavy Duty Tubular Track and Double Truck Trolleys to safely bear the increased weight load.

Door Panel Size

The door panel size (defined based on opening size) directly effects sliding door choices. A panel measuring below 144 square feet can utilize either Kwik Frame or Bigg Frame System -- but panels with larger measurements should employ the Bigg Frame System for increased frame rigidity and safer use.

GLOSSARY OF TERMS

Girt: A horizontal structural component of a door frame that connects directly to the steel door panel; also referred to as a "horizontal." CannonBall Sliding Door Systems employ steel girts for increased strength, rigidity and durability.

Side Rail: The door frame's vertical component that, unless using a double couple, goes on each side of one panel.

Double Couple: A door frame component that replaces one side rail, used to eliminate gap between two door panels and add structure.

Bottom Rail: The bottom portion of a door frame; not to be confused with a bottom girt.

Frame: The overall structure of the door. A complete panel frame typically consists of a bottom rail, multiple structural girts and two side rails (NOTE: depending on frame design, a double couple may replace one side rail).

Panel: A flat or curved component, typically rectangular, that forms or is set into the surface of a sliding door

Bypass: A sliding door installation consisting of multiple panels where at least one panel is close to the building with another in front of it. Typically used in instances of space constraints along the sides of an opening.

Split Slider: A type of sliding door installation consisting of two or more panels that line up on the same plane, with panels placed to the left and right of each other.

Opening Size: The height and width of the opening in the building; also called the rough opening.

Door Size: The height and width of the door panels. Typically total door panel size is about 2 inches taller and 4 inches wider than the opening size.

Door Frame Components

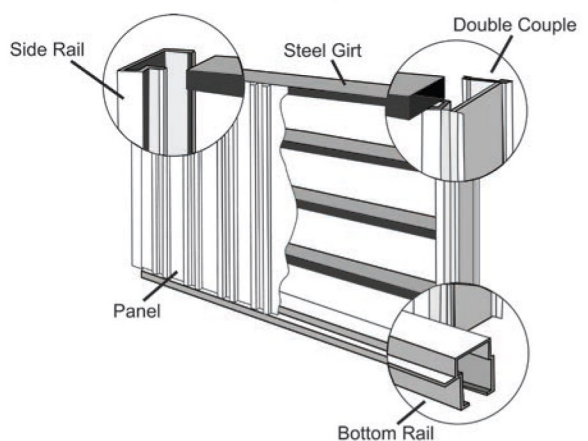

ACCESSORIES / OPTIONS

See Hardware & Project Prep section (page 17) for details

-  Agriculture 
-  Commercial 
-  Metal 

COMPLETE DOOR SYSTEMS

KWIK FRAME® SLIDING DOOR SYSTEM

Complete solutions for standard sliding door projects

Developed as a complete, cohesive assembly, CannonBall's Kwik Frame system comes together in an easy, standard assembly – regardless of door panel sizing. Frames combine sturdy design and lightweight materials for straightforward construction on panels **under 144 square feet**.

FEATURES:

- Designed for buildings with roll-formed steel siding, Kwik Frame Systems remove the guesswork and labor associated with field-fabricated doors.
- The versatile system design allows for adaptation into a wide assortment of special applications including bypass, split-slider and multi-panel doors.
- All exterior components come with a powder coat finish (color matching available) for a durable, quality appearance that will outlast paint under all weather conditions.
- The basic design, standardized components and lack of specialized labor offer cost effective alternatives to costly overhead door systems – and the benefits grow as the opening size increases.
- Ideal for smaller size door panels (under 144 square feet), Kwik Frame System components come together with fewer pieces in standardized assemblies for easy installation.
- Most standardized components and options are quick ship items – providing needed parts in days (not weeks) and lowering overall inventory levels.
- CannonBall's Kwik Frame 100-Series and 200-Series are both constructed from the same extruded aluminum, but are differentiated by their own unique dimensions.



100-SERIES

150 Side Rail

FEATURES:

- Sturdy, rust-free aluminum materials offer long lasting functionality, finished look and quick assembly.
- Optional vinyl weather seal can easily slide into the built-in T-slot for quick, easy weather sealing.



200-SERIES

200 Side Rail

FEATURES:

- With a self-flashing J-Channel, the 200 Side Rail provides easy door panel installation.
- Side rail profile conceals all exposed steel, giving the panel a clean and smooth finish.



160 Double Couple

FEATURES:

- Helps to manage poor weather conditions by eliminating the natural gap between door panels.
- Offers a strong connection while it increases unit durability and sliding door system longevity.



216 Double Couple

FEATURES:

- Eliminates the gap that naturally forms at the connection point of two door panel edges.
- A built-in J-Channel offers easy installation of the door panel skin.



170 Bottom Rail

FEATURES:

- Can be used with a continuous guide rail or stay roller to provide optimal wind resistance.
- The strong aluminum construction helps to save uncost by eliminating the additional bottom horizontal girt.



244 Bottom Rail

FEATURES:

- Designed to conceal a guide rail or stay roller - preventing door sway and providing clean operation.
- Two built-in channels allow for the use of an optional vinyl or brush seal to keep out dust, dirt, rain and snow.



www.cnbhnp.com

235 Steel Girt (Horizontal)

Durable door frame support

Designed for ideal horizontal support on sliding door frames, the 235 Steel Girt is a 20-gauge galvanized steel beam sized for optimal door frame construction and support.



FEATURES:

- Long lasting, rust-free materials avoid the rotting and warping issues associated with 2x4 lumber.
- The hollow girt design offers more strength and less weight than comparable lumber horizontals, providing easier installation and lighter full-assembled doors.

KWIK FRAME SPECIFICATIONS

	150 Side Rail	160 Double Couple	170 Bottom Rail	235 Steel Girt
Weight per ft	0.71 lbs	0.81 lbs	0.68 lbs	1.3 lbs
Thickness for horizontal girts	1-1/2"	1-1/2"		
Overall thickness	2-1/2"	2-1/2"	2-1/2"	3-1/2" x 2"
Use w/seals	✓			
Replaces bottom girt			✓	
Use w/guide rail			✓	

Keyhole® Track

Adaptable design for the widest variety of doors

CannonBall's Keyhole Track offers versatility, strength and ease of use. This adaptable track style can be used with any sliding door variety or bracket type – and installs with a simple connection of brackets into keyholes before mounting.



FEATURES:

- Keyhole Track can be utilized in both wood and metal frame construction for commercial, agriculture and metal building projects.
- Flexibility in design is matched with a wide assortment of compatible brackets – providing configurations for numerous building applications.
- When paired with Delrin wheel trolleys, Keyhole Track handles sliding doors weighing up to 600 pounds.
- Choose from a variety of bracket styles to accommodate track cover additions on doors up to 2-1/2" thick.
- Cylindrical design allows for self-cleaning and aligning with every use, positioning trolleys in the track center and pushing away any dirt or debris build-up.

Delrin Pendant Bolt Trolleys

Stability, functionality and a smooth roll

With superior materials and multidirectional adjustment, available Delrin Pendant Bolt Trolleys are hard-wearing in use and flexible in mounting. Pair them to hold door panels weighing up to 600 pounds.



FEATURES:

- The Delrin wheel material provides rust-free hardness, long-lasting functionality and ease of use.
- Offset Pendant Bolt Trolley varieties can be adjusted four ways (up, down, in & out) for adaptable installation of both wood and metal framed door panels.
- While comparable steel wheel designs max out their loads at 450 pounds per pair, Delrin trolley pairs can handle door panels up to 600 pounds.
- CannonBall offers the Pendant Bolt in a variety of lengths to meet your project's vertical adjustment needs.

Agriculture Commercial Metal 

COMPLETE DOOR SYSTEMS

BIGG FRAME® SLIDING DOOR SYSTEM

Sturdy, durable solution for larger sliding doors

Designed to work together as a complete system, Bigg Frame Sliding Door components provide an easy, standard assembly for sliding door panels up to 20'x20' in size. Ideal for panels **larger than** 144 square feet, the Bigg Frame System is a durable solution for high-wind locations or large-scale doors.

FEATURES:

- The Bigg Frame System is ideal for large door panels over 144 square feet – offering a standardized construction, fewer components and easy assembly.
- Designed for buildings with roll-formed steel siding, Bigg Frame removes the guesswork and labor associated with field-fabricated doors.
- The versatile system design allows for adaptation into a wide assortment of special applications including bypass, split-slider and multi-panel doors.
- All exterior components come with a powder coat finish (color matching available) for a durable, quality appearance that will outlast paint under all weather conditions.
- Most standardized components and options are quick ship items – providing needed parts in days (not weeks) and lowering overall inventory levels.
- The wider sizing of the Bigg Frame System -- when paired with available 235 steel girts -- provides each door panel greater durability and increased wind resistance. NOTE: This system is NOT recommended for wood horizontals.



391 Side Rail

Sturdy & durable sliding door panel edges

Designed specifically for larger door panels, Bigg Frame's 391 Side Rails offer self-flashing J-channels to enclose steel door skins for a trouble-free hold and easy installation.

FEATURES:

- Sturdy, rust-free aluminum materials offer long-lasting functionality, finished looks and quick assembly.
- Side rail profile wraps and conceals all exposed steel edges, giving the panel a smooth look that won't cut or scratch.
- An optional vinyl weather seal can easily slide into the built-in T-slot for quick, easy weather sealing.



396 Double Couple (H-rail)

Conceals and seals sliding door panel gap

Larger sliding doors demand strong connections to keep out the elements – and the Bigg Frame 396 Double Couple handles the job with greater stability than standard H-rails.

FEATURES:

- The Double Couple is designed to replace one side rail -- aligning both sliding door panels together when the door is closed.
- H-rail functionality wraps the edge of the joining door panel for a sturdy connection, increased unit durability and added sliding door system longevity.
- A built-in, self-flashing J-channel offers easy installation of the door panel skin.



394 Bottom Rail

Robust sliding door component with weather sealing ability

Designed to accommodate a continuous guide rail, the 394 Bottom Rail delivers increased wind resistance and diminished sliding door sway during use.

FEATURES:

- When used in conjunction with a continuous guide rail, the 394 Bottom Rail offers ease of use and protection of building siding.
- Two built-in channels within the rail allow for the use of an optional vinyl or brush seal to keep out dust, dirt, rain and snow.

www.cnbhnp.com

235 Steel Girt (Horizontal)

Durable door frame support

Designed for ideal horizontal support on sliding door frames, the 235 Steel Girt is a 20-gauge galvanized steel beam sized for optimal door frame construction and support.

FEATURES:

- Long lasting, rust-free materials avoid the rotting and warping issues associated with 2x4 lumber.
- The hollow girt design offers more strength and less weight than comparable lumber horizontals, providing easier installation and lighter full-assembled doors.



BIGG FRAME SPECIFICATIONS

	391 Side Rail	396 Double Couple	394 Bottom Rail	235 Steel Girt
Weight per ft	0.94 lbs	1.02 lbs	1.21 lbs	1.3 lbs
Thickness for horizontal girts	3-1/2"	3-1/2"		
Overall thickness	4-1/2"	4-1/2"	4-1/2"	3-1/2" x 2"
Use w/seals	✓		✓	
Replaces bottom girt			✓	
Use w/guide rail			✓	

Quick Track **All-in-one track and cover combo**

Quick Track blends a 14-gauge galvanized steel track with a built-in, 18-gauge, white finish cover. The results speak for themselves: added strength, consistent functionality and increased weather protection on 4-1/2" thick door varieties.

FEATURES:

- Created for use with the Bigg Frame Sliding Door System, Quick Track delivers an easy top mount installation and a clean, finished look for your sliding door.
- The self-aligning track automatically centers the trolleys in the track and pushes any dirt/debris out of the way for the ultimate in low-maintenance design.
- While the track is compatible with standard end caps, Quick Track also offers a line-specific end cap and cover trim option to discourage animal / bird nesting.
- While ideal for agriculture and commercial building projects, Quick Track can also be used on metal building construction with the addition of a header.



Delrin Pendant Bolt Trolleys

Stability, functionality and a smooth roll

With superior materials and multidirectional adjustment, available Delrin Pendant Bolt Trolleys are hard-wearing in use and flexible in mounting. Pair them to hold door panels weighing up to 600 pounds.

FEATURES:

- The Delrin wheel material provides rust-free hardness, long-lasting functionality and ease of use.
- Offset Pendant Bolt Trolley varieties can be adjusted four ways (up, down, in & out) for adaptable installation of both wood and metal framed door panels.
- While comparable steel wheel designs max out their loads at 450 pounds per pair, Delrin trolley pairs can handle door projects up to 600 pounds.
- CannonBall offers the Pendant Bolt in a variety of lengths to meet your project's vertical adjustment needs.



Agriculture ✓

Commercial ✓

Metal ✓

TRACK & TROLLEY SYSTEMS



KEYHOLE® TRACK

Adaptable design for the widest variety of doors

CannonBall's Keyhole track offers versatility, strength and ease of use. This adaptable track style can be used with any sliding door variety or bracket type – and installs with a simple connection of brackets into keyholes before mounting.

FEATURES:

- Keyhole Track can be utilized in both wood and metal frame construction for commercial, agriculture and metal building projects.
- Flexibility in design is matched with a wide assortment of compatible brackets – providing configurations for numerous building applications.
- When paired with available Delrin wheel trolleys, Keyhole Track can manage sliding doors weighing up to 600 pounds.
- Choose from a variety of bracket styles to accommodate track cover additions on doors up to 2-1/2" thick.
- Cylindrical design allows for self-cleaning and aligning with every use, positioning trolleys in the track's center and pushing away any dirt or debris build-up.
- Keyhole track is offered in a variety of standard lengths (2-foot increments) for ease of order and total inventory reduction.



DELRIN PENDANT BOLT TROLLEYS

Stability, functionality and a smooth roll

With superior materials and multidirectional adjustment, Delrin Pendant Bolt Trolleys are hard-wearing in use and flexible in mounting. This durable trolley variety, when used in pairs, holds door panels weighing up to 600-pounds – while still offering the smoothest roll around.

FEATURES:

- The Delrin wheel material provides rust-free hardness, long-lasting functionality and ease of use.
- Offset Pendant Bolt Trolley varieties can be adjusted four ways (up, down, in & out) for adaptable installation of both wood and metal framed door panels.
- While comparable steel wheel designs max out their loads at 450 pounds per pair, Delrin Trolley pairs can handle door projects up to 600 pounds.
- CannonBall offers the Pendant Bolt in a variety of lengths to meet your project's vertical adjustment needs.



New RED ROLLERS on popular models!

BRACKET TYPES



Face Mount Brackets

Designed for use on CannonBall's Keyhole Track line, Face Mount Brackets contain an integral rivet that interlocks into the keyhole slot. Simply tap the bracket into each slot and mount to the face of the header board.

FEATURES:

- Choose from several bracket styles that can be used with or without optional track covers.
- Simple assembly provides a quick, easy way to install track on your building project.
- Available pre-riveted onto Keyhole Track (contact CannonBall for availability details).



Top Mount Brackets

Like the Face Mount version, Top Mount Brackets are made with rivets that interlock into keyhole slots – and allow for mounting on top of the header board.

FEATURES:

- The bracket profile supports track cover additions for added weather protection.
- Product installation and assembly is simple, straightforward and intuitive.
- Available pre-riveted onto Keyhole Track (contact CannonBall for availability details).



Face Mount Bigg Frame® Bracket

This bracket variety is specific for Bigg Frame Sliding Door systems utilizing Keyhole Track.

FEATURES:

- Works best on door varieties measuring less than 4-1/2" thick.
- Heavy-duty bracket for heavy door projects.
- Easy assembly – easy installation.



Universal Side Bracket / Universal Ceiling Bracket

Designed for use on heavy weight sliding door projects utilizing Heavy Duty & Keyhole Track varieties, Universal Side Brackets and Universal Ceiling Brackets mount easily for the specific applications.

FEATURES:

- Both Universal Brackets support sliding doors with weights over 600 pounds (when used in conjunction with appropriate Heavy Duty Track and spaced every foot on center).
- Universal Ceiling Brackets can be utilized to mount directly to a ceiling beam or truss for added design flexibility in tight spaces with limited head room.
- The versatile design of these brackets allow for use as end brackets, intermediate brackets or splice collars – depending on your building project's needs.



Universal Double Bracket

The Universal Double Bracket – an ideal choice for double track runs – allows two lengths of Heavy Duty or Keyhole track to be installed in parallel for bypass sliding doors.

FEATURES:

- Like the Universal Side Bracket, the Universal Double supports sliding doors with weights over 600 pounds (when used in conjunction with appropriate Heavy Duty Track and spaced every foot on center).
- Highly recommended for bypass sliding door configurations.
- The versatile design of the bracket allows for use as an end bracket, intermediate bracket or splice collar – depending on your building project's needs.



Universal Bolt Bracket & Bolt Adapter / Triangle Bracket

Created to bridge post frame components into metal building projects, the Universal Bolt Bracket / Bolt Adapter and Triangle Bracket allow builders to convert Keyhole Track into Bolt Hung Track functionality.

FEATURES:

- A wide variety of Triangle Brackets can pair with standard Bolt Adapters to give a range of ideal pairings for metal building installations.
- Triangle Brackets can also be used to install Bolt Hung Track in instances where the track cannot be placed directly on a metal building structural component.
- Universal Bolt Brackets provide a second route to take Keyhole track to Bolt Hung functionality.
- Satisfy your weather protection needs with optional Triangle Bracket cover retainers – then add that necessary track cover.



TRACK & TROLLEY SYSTEMS

ADDITIONAL TRACK OPTIONS

Quick Track All-in-one track and cover combo

Quick Track blends a 14-gauge galvanized steel track with a built-in, 18-gauge, white finish cover. The results speak for themselves: added strength, consistent functionality and increased weather protection on 4-1/2" thick door varieties.

FEATURES:

- Created for use with the Bigg Frame Sliding Door System, Quick Track delivers an easy top mount installation and a clean, finished look for your sliding door.
- The self-aligning track automatically centers the trolleys in the track and pushes any dirt/debris out of the way for the ultimate in low-maintenance design.



Heavy Duty Tubular Track Substantial design and construction for the heaviest doors

Created to support door panels substantial in size and weight, Heavy Duty Tubular Track offers added strength and solidity with its 13-gauge, high-carbon galvanized steel materials.

FEATURES:

- The brawny track design can support door panels with weights up to 1,200 pounds – when supported with Delrin wheel double-truck trolleys and universal brackets spaced every 12" on center.
- By varying bracket choices, this track type can handle the widest variety of door sizes – and save in total inventory costs as a singular go-to product offering.



Bolt Hung Track Ideal choice for metal building projects

Created with metal building construction in mind, Bolt Hung Track allows for direct mounting to a building's structural member without an additional header – saving labor time and project cost.

FEATURES:

- Factory mounted bolts appear every two feet on Bolt Hung Track's surface, pairing with metal building-specific brackets for a simple nuts-and-washers installation.
- The track's sturdy, 14-gauge, galvanized steel construction – when combined with Delrin wheel trolley pairs – can support sliding door panels with weights up to 600 pounds.
- Also recommended as the best choice for Bigg Frame Sliding systems utilizing bypass door configuration – regardless of building project type (post frame or metal building).



Face/Top Mount Starline Track Classical design for traditional structures

Starline Track is a cornerstone of the post frame industry. With its 14-gauge galvanized steel design it's made to withstand the elements in any environment.

FEATURES:

- Face-Mount and Top-Mount Starline Track are highlighted by their 14-gauge galvanized brackets.
- Brackets are spaced at 2-foot intervals and are **WELDED** for premium support.
- Welded brackets maintain the same level of performance to that of riveted brackets.

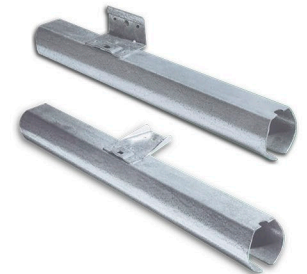

ROUND TRACK TECHNICAL SPECS

Track Type	Keyhole	Bolt Hung	Heavy Duty Tubular	Quick Track	Starline	Keyhole Bracket Track
Material	14 ga. Galvanized steel	14 ga. Galvanized steel	13 ga. High carbon galvanized steel	14 ga. Galvanized steel	14 ga. Galvanized steel	14 ga. Galvanized steel
Mount Style	Any	Face Mount (w/brackets)	Any	Top Mount	Top or Face Mount	Top or Face Mount
Panel Weight Load						
Per delrin trolley pair	600 lbs	600 lbs	600 lbs	600 lbs	600 lbs	600 lbs
Per steel trolley pair	450 lbs	450 lbs	450 lbs	450 lbs	450 lbs	450 lbs
Per double truck trolley pair Brackets 12" on center	1,000 lbs	n/a	1,200 lbs	n/a	n/a	n/a
Factory-riveted mounting				Mounting strip		Brackets
Track weight per foot	2 lbs	2 lbs	2.2 lbs	3.8 lbs	2 lbs	2 lbs

ADDITIONAL TROLLEY OPTIONS

Double Truck Trolleys

Built to handle the heaviest sliding door panels, Double Truck Trolleys are the perfect choice for steel frame doors on Heavy Duty Tubular Track with Universal Bracketry.

FEATURES:

- Model varieties include Delrin wheel or steel wheel models.
- The product design features four wheels per trolley, allowing it to support door weights up to 1200 pounds per Delrin-wheeled pair (900 pounds per steel-wheeled variety) -- when used in conjunction with Heavy Duty Track and brackets spaced every 12" on center.
- An optional plate sits just below the top girt, preventing the bolt hole from distorting.
- Double Truck Trolleys have a variety of bolt styles and length options to provide extra flexibility in mounting.



Pendant Bolt Trolleys

Ideal for framed door panel projects, Pendant Bolt Trolleys offer a wide variety of bolt lengths and styles to fit your specific needs.

FEATURES:

- Recommended for steel frame doors, these trolleys have a variety of bolt style and length options that provide extra mounting flexibility.
- The Pendant Bolt installs through the top of the horizontal, allowing for easy adjustment and a perfect fit.
- For maximum flexibility, the offset bolt version offers four directions of adjustment: up, down, in and out.



Strap Trolleys

Strap Trolleys attach to the front face of wood panel doors, with bolts that go through the panel for a solid hold.

FEATURES:

- Varieties are available with either a single strap located at the front of the trolley, or individual straps placed in the front and rear.
- While both models are ideal for solid wood doors, Front Strap Trolley models are intended for 1-1/2" thick panels – and Front & Rear Strap models are designed for panels up to 1-13/16" thick.
- Front Strap Trolleys offer four directions of adjustment to provide a better door panel fit.



Front/Rear Strap

Front Strap

ROUND TRACK TROLLEY SPECS

Trolley Style	Wheel Material	Attachment Method	Max Weight (1 pair per panel)	Adjustment Directions	Door Material Recommendation	Standard Door Thickness
Delrin Offset Pendant Bolt	Delrin	Single Bolt	600 lbs	Up, Down, In, Out	Wood / Metal Frame	Up To 6"
Delrin Straight Bolt	Delrin	Single Bolt	600 lbs	Up, Down	Wood / Metal Frame	Up To 6"
Delrin Front Strap	Delrin	Strap	600 lbs	Up, Down, In, Out	Solid Wood Only	Up To 1-1/2"
Delrin Front/Rear Strap	Delrin	Front & Rear Strap	600 lbs	Up, Down	Solid Wood Doors	Up To 1-13/16"
Delrin Non-adjustable Strap	Delrin	Strap	600 lbs	None	Solid Wood Doors	Up To 1-1/2"
Steel Offset Pendant Bolt	Steel	Single Bolt	450 lbs	Up, Down, In, Out	Wood / Metal Frame	Up To 6"
Steel Straight Bolt	Steel	Single Bolt	450 lbs	Up, Down	Wood / Metal Frame	Up To 6"
Steel Front Strap	Steel	Strap	450 lbs	Up, Down, In, Out	Solid Wood Doors	Up To 1-1/2"
Steel Front/Rear Strap	Steel	Front & Rear Strap	450 lbs	Up, Down	Solid Wood Doors	Up To 1-13/16"
Steel Non-adjustable Strap	Steel	Strap	450 lbs	None	Solid Wood Doors	Up To 1-1/2"
Delrin Double Truck (for use w/Heavy Duty Tubular Track)	Delrin	Single Bolt	1,200 lbs	Up, Down, In, Out	Wood / Metal Frame	Up To 6"
Steel Double Truck	Steel	Single Bolt	900 lbs	Up, Down, In, Out	Wood / Metal Frame	Up To 6"

- Agriculture** ✓
- Commercial** ✓
- Metal** ✓

TRACK & TROLLEY SYSTEMS



SQUARE TRACK

Classic, versatile, and flexible design

CannonBall's square track is designed for flexibility and economy in sliding door systems weighing up to 400 lbs. Suitable for use indoors and out. CannonBall's square track can be installed with or without a cover in top mount, face mount, or double run - face mount configurations.

FEATURES:

- Manufactured from 16 gauge galvanized steel, CannonBall square track is available in lengths from 8 to 20 feet.
- All models of CannonBall square track are compatible with our full family of non-bearing, Delrin bearing and roller bearing trolley hangers.
- With tradition in mind, Cannonball uses the same technology and track design that has worked for over 100 years.

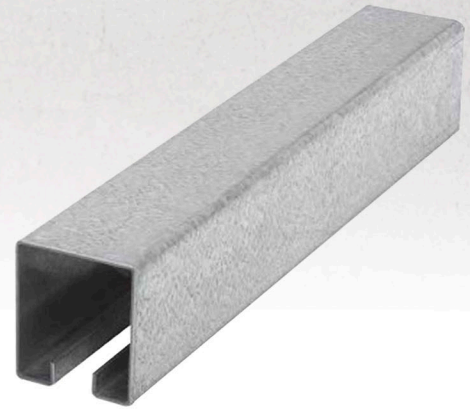
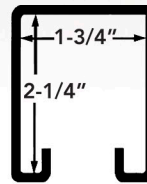

- CannonBall square track can be installed with or without a cover in top mount, face mount, and double-run face mount configurations.
- A wide variety of brackets are available for face mount, overhead mount, bolt hung, and double run applications.

ADJUSTABLE STRAP TROLLEY

Traditional and long-lasting design

The one-piece apron door strap hanger is laterally and vertically adjustable. Comes with 6-5/16" -2-1/2" carriage bolts for attaching door straps; supports door up to 400 lbs.

FEATURES:

- CannonBall's adjustable square track trolleys come in a variety of bearing constructions:
 - Non-Bearing - Economical design with no bearings to wear out over time or fail.
 - Delrin Bearing - Still economical but provides easier and quieter operation of the door.
 - Roller Bearing - Our best trolleys, provide easiest operation and are virtually noise free.
- Straps bolt through the face of the door and attach to the trolley using a modified pendant bolt.



ADDITIONAL TRACK OPTIONS

Covered Square Track (White & Galvanized)

Ultimate in ease of installation

Covered Square Track from CannonBall offers the ultimate in ease of installation - line it up, fasten it, and you're done. Manufactured from our standard square track, all covered square tracks are compatible with the full family of CannonBall hangers and accessories, and are suitable for sliding doors weighing up to 400 lbs.

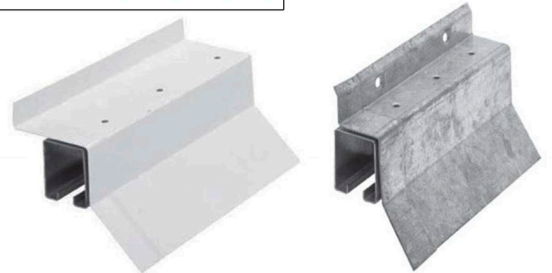

FEATURES:

- Heavy duty track covers are pre-ripped to the track for maximum strength and fast installation.
- Top Mount White Covered Track features a durable, backed-on white finish that accents most building colors - no additional painting required.
- Face Mount Galvanized Covered Track can be painted in the field to match any building color, or can be left unpainted if desired.

FNF Square Track System

Pre-ripped to suit various applications

The FNF Square Track System from CannonBall features a unique bracket design suitable for a Flashing or Non-Flashing application. Mounting brackets are pre-ripped to the track for quick and easy installation with no obstructions. A separate flashing bracket can be tapped into slots of the mounting brackets if flashing is needed.

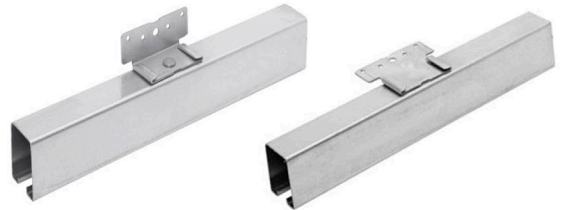

FEATURES:

- FNF Square Track is made from standard square track allowing use of all existing CannonBall square track hangers and accessories. Suitable for use on sliding doors weighing up to 400 lbs.
- Available in top and face mount configurations in lengths from 8 to 20 feet. The same flashing bracket is used for both top and face mount FNF tracks.
- Provides the ease of installation of a snap-on flashing bracket with strength comparable to a one-piece flashing bracket.

Top Mount Bracket Square Track

Strong, durable, and easy to install

The most popular square track type on the market today. Top Mount Bracket Square Track is strong, durable, and easy to install. Manufactured using our standard square track, Top Mount Bracket Square Track is compatible with all existing CannonBall square track hangers and accessories and is suitable for use on sliding doors weighing up to 400 lbs.

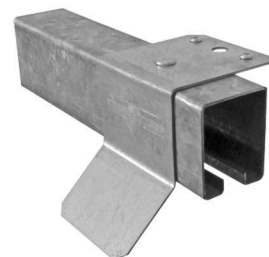

FEATURES:

- The one-piece, top mount brackets allow for clear access to mounting holes, provide a solid hold point for positioning and handling the track, and cannot be blown apart by high winds.
- Top mount brackets feature a wide design for greater contact between bracket and flashing for maximum strength.
- Top Mount Bracket Square Track is available in lengths from 8 to 20 feet.
- Brackets are **RIVETED** to the track to meet your project needs.

Agriculture Commercial Metal 

TRACK & TROLLEY SYSTEMS

ADDITIONAL TRACK OPTIONS

WP Top Mount Bracket Square Track

WP Top Mount Bracket Square Track offers projection WELDED brackets, and are placed approximately 24 inches on center.

FEATURES:

- Manufactured from 16-gauge galvanized steel and can support doors weighing up to 400 lbs.
- Track attaches with 1-1/2" ring shank neoprene washer nails. (5/16" lag screws or bolts may also be used if desired.)
- Available in 8, 10, 12, 14, 16, and 20 foot lengths.

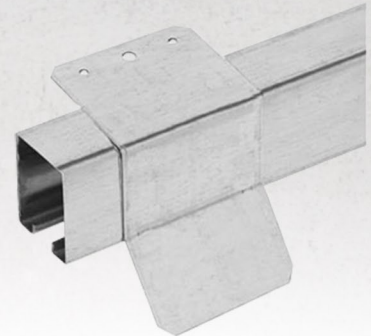

Heavy Duty Square Track

CannonBall's newest product to join it's extensive family of tracks is the Heavy Duty Square Track System. This system holds the capabilities to support weights up to 1000 lbs. while maintaining a long and functionable life. The heavy duty system is suitable to be used with the newly introduced heavy duty square track trolleys and accessories.

FEATURES:

- For doors 2-1/4" to 3-1/4" thick, weighing up to 1000 lbs., if brackets are spaced no more than 18" on center.
- Extra heavy duty 13-gauge track with galvanized finish for long corrosion-free life.
- Available in 8, 10, and 12 foot lengths.

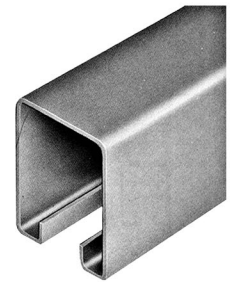
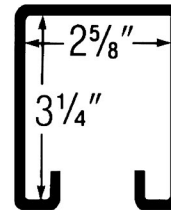

TROLLEY OPTIONS

Standard Square Track Trolleys

All CannonBall standard square track trolley hangers are designed for use in pairs on sliding doors weighing up to 400 lbs.

FEATURES & TROLLEY TYPES:

- **Pendant Bolt Trolleys** are suitable for use on all types of sliding doors. A hole is drilled in the top horizontal of the door for attaching the bolt. The offset of the bolt allows for 4-way adjustment of the door.
- **Easy Adjust Trolley hangers** feature a straight pendant bolt mounted on a separate adjustment bolt. The bolt provides vertical adjustment while the adjustment bolt is used to adjust the door in or out from the building.
- **Strap Trolleys** are designed for use with wood doors. A variety of straps are available for various door, installation and adjustment options.
- **Bolt Thru Trolley** are designed for applications where only vertical adjustment is required.

Easy Adjust



Pendant Bolt



Strap



Bolt Thru



ADDITIONAL TROLLEY OPTIONS

Heavy Duty Square Track Trolleys

Built to handle the heaviest sliding door panels, Heavy Duty Trolleys are a great complement to CannonBall's Heavy Duty Square Track. Together they can handle doors up to 1000 lbs. (For doors 2-3/8" - 4" wide)

FEATURES:

- Made of heavy-duty 11-gauge galvanized steel, both are vertically and laterally adjustable.
- Wheels are 3" in diameter, 5/16" thick, and zinc plated.
- Bolt size is 5/8" #11 - 5" long.



BRACKET TYPES

Standard Brackets

CannonBall's standard square track brackets are built to support and accommodate its plain square track. The square track mounting brackets have several variations to accommodate different installations. Having these variations allows one track type to work for various applications which reduces inventory hassle and saves warehouse space.

FEATURES:

- Made from heavy gauge galvanized steel to support weights up to 400 lbs.
- Requires 3/8" lag screw or bolt for mounting.
- Recommended spacing when it comes installation is 24" O.C.



Heavy Duty Brackets

Built to go hand-in-hand with CannonBall's Heavy Duty Square Track. Heavy Duty Square Track Brackets are made to accommodate the mounting and securing of track. The mix of heavy duty track, brackets, and trolleys make for an incredible combination to meet the requirements and needs of a 1000 lbs. door.

FEATURES:

- Brackets are made of heavy-duty 3/16" steel, with a zinc-plated finish.
- Mounting holes accommodate 3/4" bolts or lag screws (not included).
- Offered in a wide variety of designs to assist in a multitude of applications.



SLIDING DOOR HARDWARE OPTIONS

	Agriculture
	Commercial
	Metal

Door Stop

Prevents door panels from opening or closing further than a predefined stopping point; available with a variety of options for different uses or construction preferences.



Door Pulls

Assists with door opening and closing; a handle attached to door panels.



Stay Guide™

Reduces the amount of door sway, helps prevent wind damage and provides easier door operation. Stay Guide lengths should measure 60% of the door panel width.



Splice Collar

Connects track lengths together to make a single, elongated track. NOTE: Shorter track lengths utilizing Splice Collars save on shipping cost and install easier than long track lengths.



Stay Roller

Functions similarly to a guide rail, but recommended for Kwik Frame Door Systems or solid wood panel doors smaller than 140 sq. ft.



End Cap

Attaches to open ends of track, preventing birds from nesting as well as dirt and debris build-up. NOTE: End Caps cannot be used as door stops.



Vinyl Seal

A vinyl "fin" that fits into door frame channels to provide weather protection. Models available for side and bottom rails.



Door Guide/Stop

Guides the door along the building, reduces the amount of door sway and prevents opening or closing beyond a predefined stopping point.



Brush Seal

Similar to a bottom rail vinyl seal, but made up of wire brushes for increased durability.



235 Steel Girt (Horizontal)

Provides horizontal support on sliding door frames. Steel girts are manufactured with 20-gauge galvanized steel for long lasting, light weight, rust-free door framing.



Snuggers

Prevents door panels from moving or rattling when closed and tightens as the door moves; available in several styles based on intended use.



Latches

Locks doors from the inside and pulls panels tighter against the building to reduce rattle.



Number of Horizontal Girts Required

Door Panel Height	Door Panel Width (dimensions are for each individual door panel used)									
	6'	7'	8'	9'	10'	12'	14'	16'	18'	20'
8'	4	4	4	4	4	4	4	6	6	6
10'	5	5	5	5	5	5	5	7	7	7
12'	6	6	6	6	6	6	8	8	8	8
14'	7	7	7	7	7	9	9	9	9	9
16'	10	10	10	10	10	10	10	10	10	10
18'	11	11	11	11	11	11	11	11	11	11
20'	12	12	12	12	12	12	12	12	12	12







(See chart on inside back cover to see common options and quantities)

= Bigg Frame System Recommended with 3 top horizontal girts & spacers

DETERMINING SLIDING DOOR PROJECT NEEDS

Answer the following questions with regards to your sliding door project — and review CannonBall's recommendations to meet your project needs.

1.) To what type of building is the sliding door being added?

Steel Frame & Headers	Wood Frame & Headers
<p>Recommended (for easy assembly)</p>  <p>Bolt-Hung Track with Triangle Brackets & Cover Retainer</p>	<p>Recommended</p>  <p>Keyhole Track with Face Mount for Cover Brackets</p>
<p>Recommended (for easy availability)</p>  <p>Keyhole Track with Bolt Adapter, Triangle Brackets & Cover Retainer</p>	<p>Alternative</p>  <p>Quick Track</p>
<p>Alternative</p>  <p>Keyhole Track with Universal Bolt Hung Bracket, Triangle Brackets & Cover Retainer</p>	<p>Recommended (for heavy doors)</p>  <p>Heavy Duty Tubular Track with Universal Side Mount Bracket placed 12" on center.</p>
<p>Recommended (for heavy doors)</p>  <p>Heavy Duty Tubular Track, Universal Bolt Hung Bracket placed 12" on center, Triangle Brackets & Cover Retainer</p>	

2.) What variety of sliding door will be used in the project?

Single Panel (e.g. one panel covering the entire width of the opening) Door panels over 144 square feet should use the Bigg Frame System. See girt chart on previous page for number of girts.

Split Double Panel (e.g. two panels meeting in the center of the opening covering the entire width) Each door panel will need its own width/height measurement. Two trolley pairs are also required. Door panels over 144 square feet should use the Bigg Frame System. See girt chart on previous page for number of girts needed.

3.) What is the opening size?

The total door panel(s) size should be large enough to be 4" wider and 2" taller than the opening. See girt chart on previous page for the required number of girts.

NOTE: All door component lengths from CannonBall are exact lengths.

4.) Does the project require a large or heavy door?

Recommendations:

- Door panels larger than 144 square feet should utilize the Bigg Frame System.
- Door panels that weigh 600 to 1,000 pounds should use Keyhole Track, Delrin Wheel Double Truck Trolleys and Universal Brackets installed every 12".
- Door panels that weigh 1,000 to 1,200 pounds should use Heavy Duty Tubular Track, Universal Brackets installed every 12" and Delrin Wheel Double Truck Trolleys.

5.) Other items to consider.

- Finish of framing components. The standard finish is white, other colors are available with extended lead times and an upcharge.
- Desired securing method (i.e. latches, snuggers) see inside back cover for more info.
- Is weather sealing needed? If so, talk to your CannonBall rep about the vinyl and brush seal options.

REQUIRED HARDWARE COMPONENTS FOR SLIDING DOOR SYSTEMS

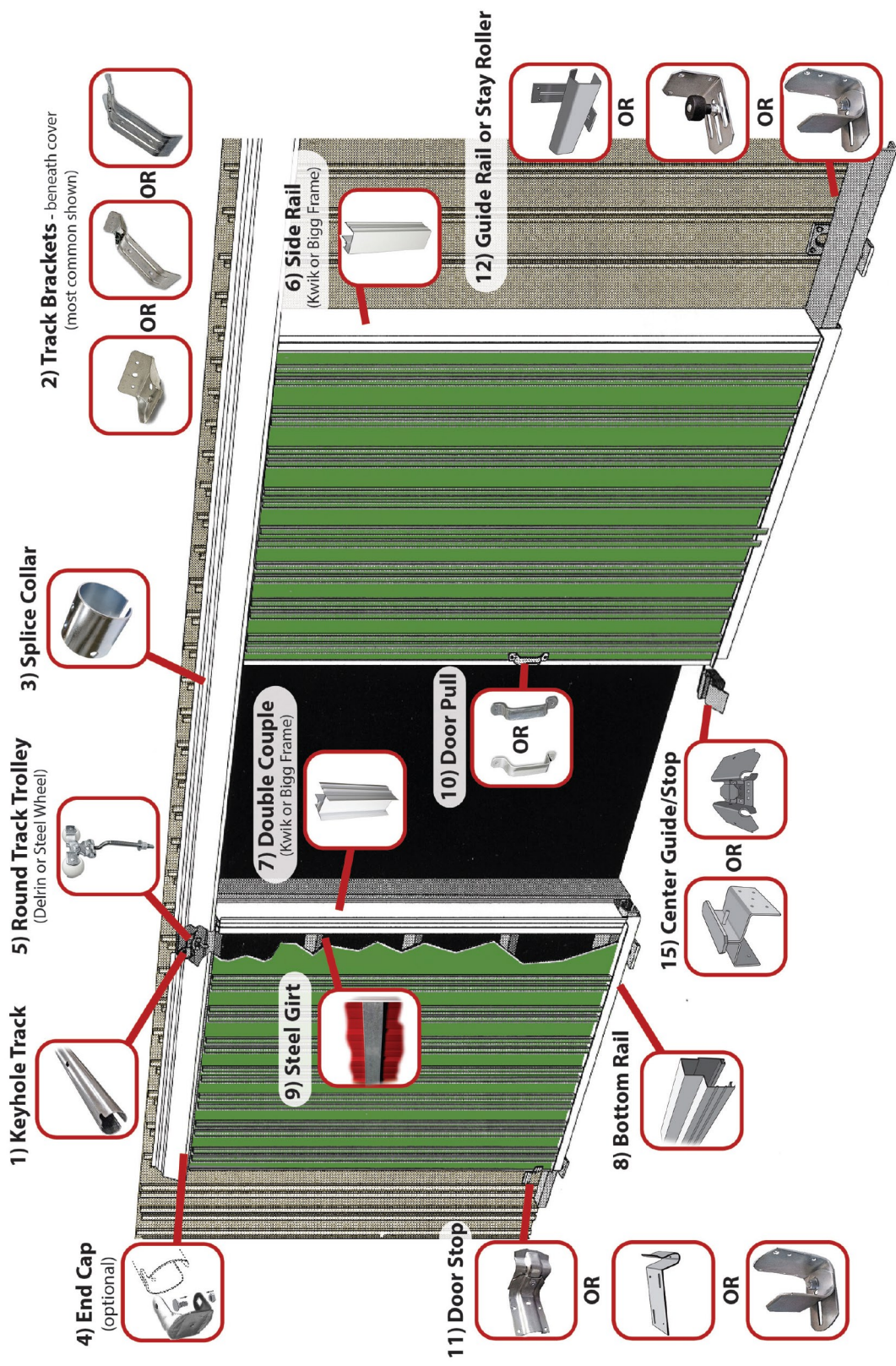

Also Required - not shown in image

13) Side Latch or Snugger

14) Center Latch or Snugger

15) Center Guide/Stop

16) Vinyl Side Seal

17) Vinyl or Brush Seal (For bottom rail)

REQUIRED NUMBER OF COMPONENTS

	SINGLE PANEL	TWO PANEL SPLIT
1) Keyhole Track - Enough track for length of run to be double the width of the opening (i.e. 10' opening = 20' track)		
2) Track Brackets - Up to 600# per panel = 1 bracket every 2' of track. Over 600# = 1 universal bracket every 1' of track.		
3) Splice Collar - One less than number of track sections (i.e. 3 pieces of track requires 2 splice collars)		
4) End Cap	1 pair	1 pair
5) Round Track Trolley	1 pair	2 pair
6) Side Rail (see chart for type)	2	3
7) Double Couple (see chart for type)	0	1
8) Bottom Rail (see chart for type)	1	2
9) Steel Girt (horizontal)	See girt chart on pg. 11	See girt chart on pg. 11
10) Door Pulls	1	2
11) Door Stops - Often mixed for aesthetic or functional reasons.	2	2
12) Stay Guide™ or Stay Roller - Stay Guide™ must be 60% of panel width & is recommended.	1	2
13) Side Latch or Snugger -Snugger also works as interior door pull.	2	2
14) Center Latch or Snugger - Snugger also works as interior door pull.	0	1
15) Center Guide/Stop	0	1
16) Vinyl Side Seal - Optional: provides weatherseal at outer side rails. Length = side rail length (order per ft)	2	2
17) Bottom Vinyl or Brush Seal - Optional: weatherseals at bottom rails. Length = bottom rail length. Able to have 2 pieces per bottom rail (order by the ft)	1 or 2	2 or 4

