

Fluorpon®

Low Sheen Paint for 16" Wide 26GA Panel

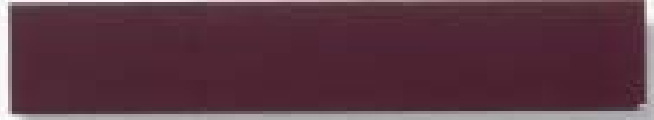

Evergreen



Burgundy

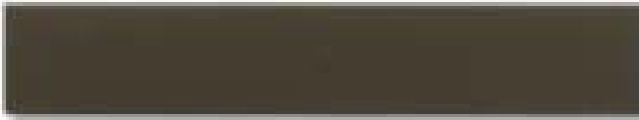

Burnished Slate

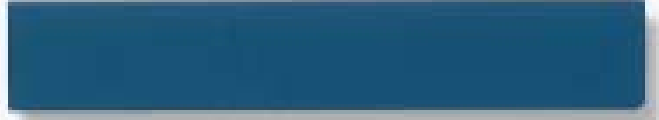

Ocean Blue



Patriot Red

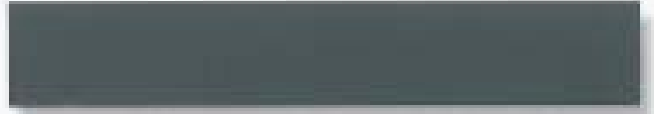

Charcoal Gray

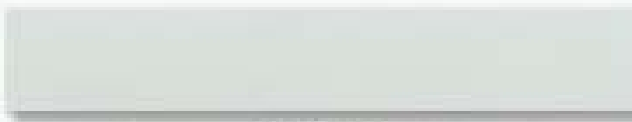

Regal White

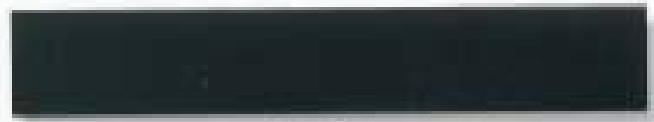

Black

Siliconized Polyester

High Gloss Paint for 12" Wide 29GA & 16" Wide 26GA Panel

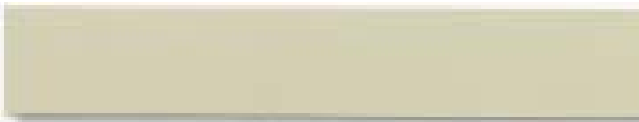

Sandstone

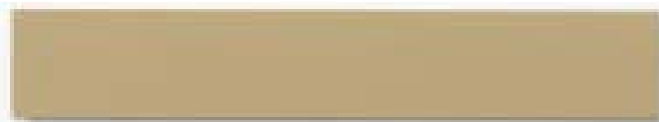

Tan

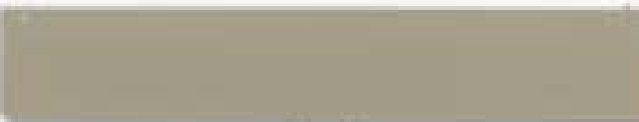

Clay



Evergreen

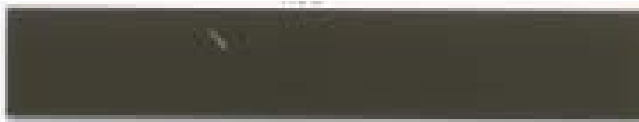

Burnished Slate

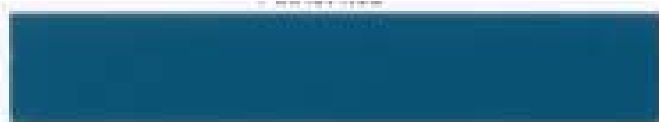

Ocean Blue

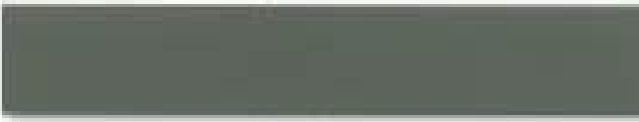

Dark Gray



Light Gray

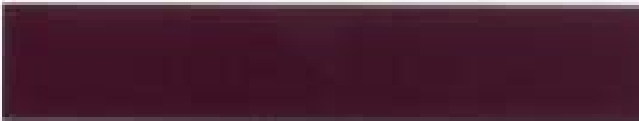

Burgundy



Patriot Red



Regal White

The colors on this card are as close to actual as color chip reproduction technology allows. Coating samples on metal are available upon request.

Standing Loc Rib (SLR)

1" High Custom Length Concealed Fastener Panel

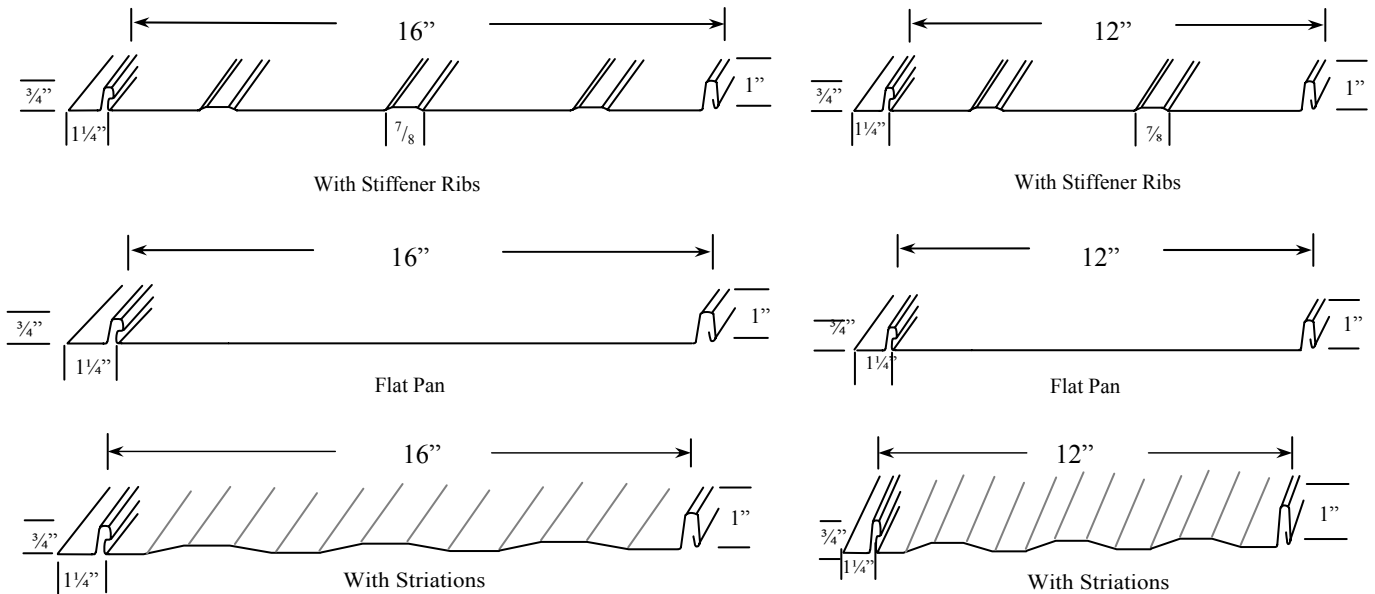

Clip Loc II

1-1/2" High Custom Length Clip Fastened Panel

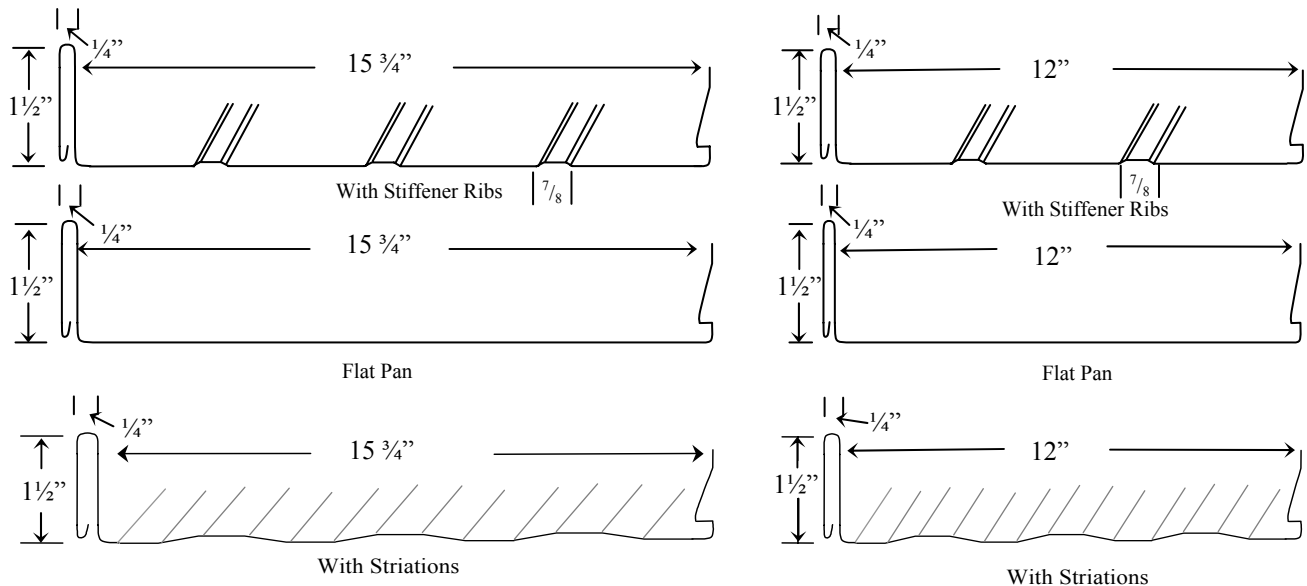

Valspar's Siliconized Polyester paint features a 40 year warranty with:

Top Coat: .2 Mils Yellow Ultra Flex Primer, .8 Mils WeatherX Siliconized Polyester
 Bottom Coat: .2 Mils Yellow Ultra Flex Primer, .3 Mils Polyester Backer

Valspar's Fluropon® Low Sheen paint features a 35 year warranty with:

Top Coat: .2 Mils DFT Primer, .8 Mils DFT Top Coat
 Bottom Coat: .2 Mils DFT Primer, .3 Mils DFT Backer

Please specify with ribs, flat pan or with striations when ordering.